

ROSCO

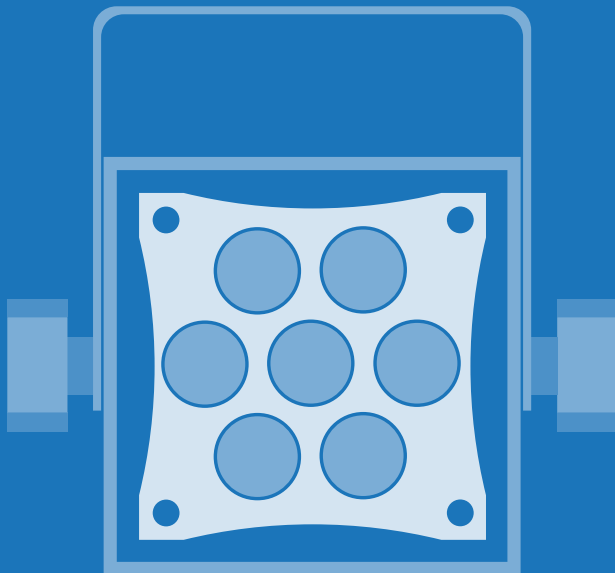

BRAQ CUBE[®]
DESIGNED BY THE BLACK TANK

USER'S MANUAL

Table of Contents

Your Braq Cube

Product Description.....	5
What's In the Box.....	7
Braq Cube Interface.....	8

Braq Cube Series

Braq Cube 4C & 4CA.....	9
Braq Cube WNC/3W.....	11

Braq Cube Modes

DMX Mode.....	12
Manual Mode.....	17
Color Wash Mode.....	20
Serial Mode.....	23

Beam Angles

Spread Lens.....	24
Changing the Spread Lens.....	25

Mounting and Configuration

Linear Array.....	26
Safety Cables.....	28

Braq Cube Support

FCC Warning.....	29
General Precautions.....	30
Warning Messages.....	31

Product Description

Braq Cube®

Rosco's innovative Braq Cube series of LED wash lights packs 100 watts outputting more than 7100 lumens into a compact and portable 5 inch cube! The sleek yet rugged, geometric design of the Braq Cube is perfectly at home in entertainment environments, museums, stores and lobbies, built into sets, truss and lighting rigs of all styles.

These luminaires offer the flexibility and versatility needed for any type of lighting challenge. No expensive external power supply or ballast is required, the Braq Cube plugs directly into the wall anywhere in the world, automatically adjusting to mains power from 90-240vAC 50-60hz. Drawing less than an amp of current, more than 20 Braq Cubes can be plugged into a single 20A circuit!

An intuitive LCD control panel sets virtually every aspect of the lights including a master-slave configuration for fast lighting set-ups. Completely flicker free diming is available via DMX (in 8 or 16 bit resolution).

Product Description

Weighing just 3-1/2 pounds, mounting these compact 5 inch cubes is limited only by the imagination of the installer. The novel through bolted yoke design allows units to be easily ganged into multi-unit strips and arrays for greater output and coverage. With a simple cable jumper you can use Braqs to output power to the adjacent fixtures.

Available in versions that offer full quad chip color mixing and tuneable color temperature white light, the Braq Cube luminaires are the smallest, most feature packed and affordable, professional grade LED wash lights on the market.

What's In the Box

[1] Braq Cube

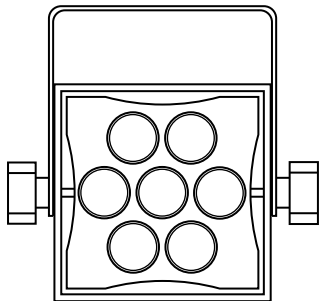

[2] Power Option

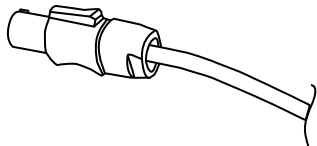

[3] Set of Symmetrical Spread Lenses

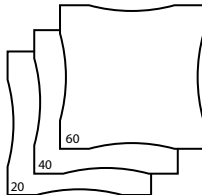

Braq Cube Interface

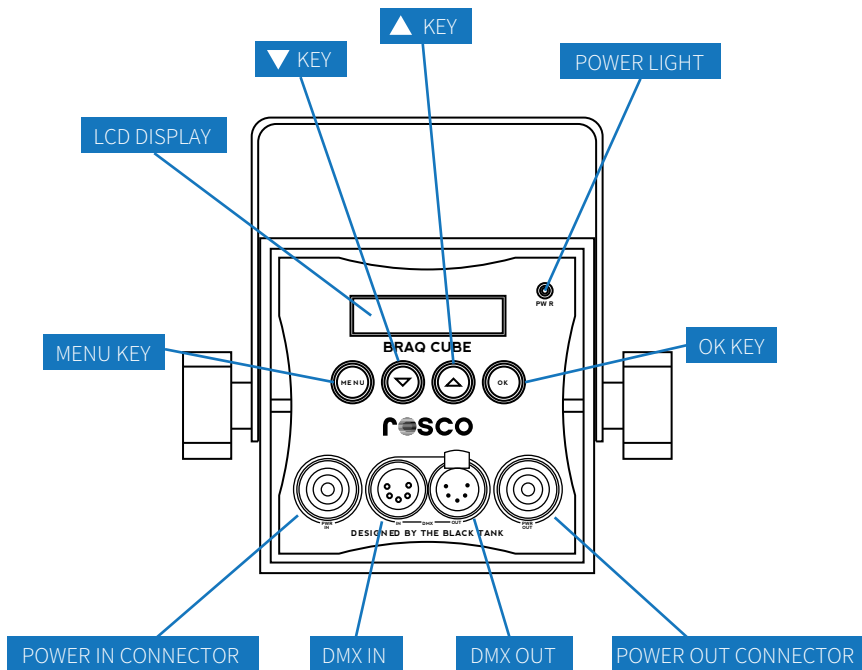

Braq Cube 4C & 4CA

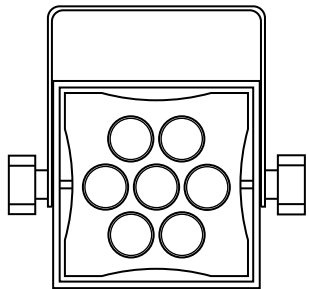

From walls to washes to uplighters, the Braq Cube 4C & 4CA color mixing wash light offers a designer maximum creativity in a tiny package. The best-in-class quad-chip emitters inside the Braq Cube RGBW 4C and the RGBA 4CA produce a gorgeous palette of saturated, mid-tone and pale tint colors. The 4C and 4CA can also mix an attractive, full spectrum white light in warm and cool color temperatures - not the unflattering compromise found in other color-mixing LED lights.

The Braq Cube 4CA features a unique, phosphor-converted amber emitter – not found in any other RGBA fixture this size. This enables it to produce an expanded palette of saturated colors and rich, warm-tones of full-spectrum white light.

Smart programming in the Braq Cube 4C & 4CA includes a stand-alone

color wash mode or allows multiple units to be easily slaved together, synchronized and offset using self-generated DMX for color chases and other dynamic lighting patterns without a console. Use it alone, configured in strips & arrays or built-in for virtually any application needing colored light - from stage, studios and location, bars and casinos, to stores, windows and lobbies.

NOTE: The luminaire should be positioned so that prolonged staring into the luminaire at a distance closer than 3.3m is not expected.

Braq Cube WNC/3W

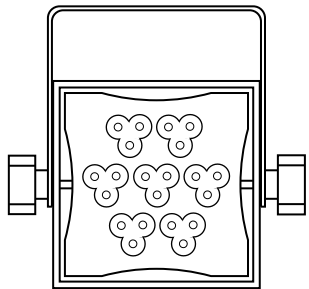

Size matters. But quality of light matters more! The Braq Cube WNC embodies what every lighting professional needs - A bright, tunable, beautiful white light. Using 21 high quality Cree XML 4W emitters, the WNC outputs 7100 lumens and can adjust from 2700K to 6500K. A mix of warm, neutral and cool LEDs insure excellent rendering across

all color temperatures making it perfect for use on TV or film sets, in retail lighting, museums, architecture, photography studios or any white light application.

A 3W option provides a fixed 2700K color temperature popular with many hospitality venues.

NOTE: The luminaire should be positioned so that prolonged staring into the luminaire at a distance closer than 0.31m is not expected.



DMX Mode

In DMX mode, the unit is controlled by the data it receives on the 5-pin XLR connectors located on the rear panel. The number of DMX channels required to control the fixture is dependent on the factory setting in use. See p.16 for Braq Cube DMX channels.

NOTE: A three-pin to five-pin XLR adapter may be used with the fixture as well.

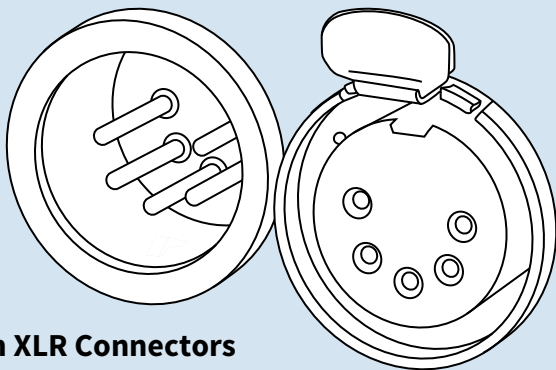

5-pin XLR Connectors



DMX Mode

There are four user settings that can be adjusted in DMX mode. The current value of each setting is shown on the main screen.



DMX Address:

To change the DMX address, press **MENU** until “**CHANGE DMX ADDRESS?**” appears on the LCD, and press **OK**. Select the desired DMX address using the **▲** or **▼** keys, and press **OK**.



DMX Mode

Universe1 or Universe2

The Braq Cube can be controlled via two unique DMX universes. DMX can be input on pins 2&3 (Universe1) or pins 4&5 (Universe2) via the 5 pin XLR connectors on the rear panel. This allows two complete universes of DMX to be transmitted on a single cable.

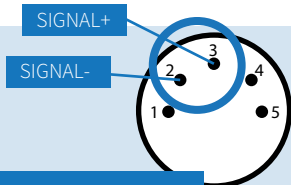

Universe 1 Wiring

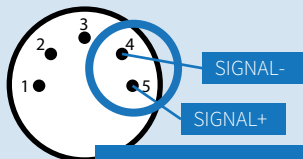

Universe 2 Wiring

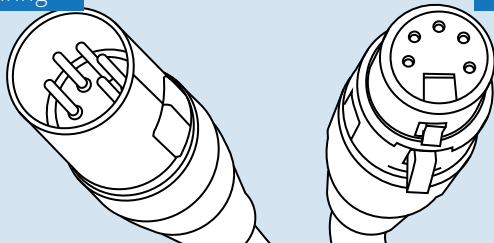

To change from Universe1 to Universe2 (or from Universe2 to Universe1) press **MENU** until “**SET TO UNIVERSE 2?**” or “**SET TO UNIVERSE 1?**” appears on the LCD, then press **OK**



DMX Mode

8 bit or 16 bit DMX:

The fixture can run in either 8 bit or 16 bit DMX mode. In 8 bit mode, The Braq Cube accepts one DMX channel for each color. In 16 bit mode, two channels are required for each color. To change from 8 bit to 16 bit mode or from 16 bit to 8 bit press **MENU** until “**SET TO 16BIT DMX?**” or “**SET TO 8BIT DMX?**” appears on the LCD, then press **OK**.

Filament Fade:

An incandescent lamp has a slight delay, or lag with changing intensities whereas an LED responds instantly. The difference is most noticeable during a theatrical black out. The Braq Cube can emulate an incandescent lamp by selecting one of the Tungsten Fade settings.

To change the Tungsten Fade setting, press **MENU** until “**CHANGE FILAMNT FADE?**” appears on the screen, and press **OK**. Select from “**OFF**”, “**1 (MIN)**”, “**2 (MID)**” or “**3 (MAX)**” using the **▲** or **▼** keys, and press **OK**. A setting of “**3 (MAX)**” provides the greatest delay. A setting of “**0**” will turn the Filament Fade off, and allow the LEDs to respond instantly to changing DMX input.



DMX Mode

DMX Channel Layout:

8 BIT MODE:

4C & 4CA

- 1 - Red
- 2 - Green
- 3 - Blue
- 4 - White/Amber

WNC

- 1 - Warm
- 2 - Neutral
- 3 - Cool

3W

- 1 - All Warm LEDs

16 BIT MODE:

4C & 4CA

- 1 - Red Coarse
- 2 - Red Fine
- 3 - Green Coarse
- 4 - Green Fine
- 5 - Blue Coarse
- 6 - Blue Fine
- 7 - White/Amber Coarse
- 8 - White Fine

WNC

- 1 - Warm Coarse
- 2 - Warm Fine
- 3 - Neutral Coarse
- 4 - Neutral Fine
- 5 - Cool Coarse
- 6 - Cool Fine

3W

- 1 - All Warm LEDs Coarse
- 2 - All Warm LEDs Fine



Manual Mode

WARNING: DO NOT CONNECT ANY BRAQ CUBE IN MANUAL MODE TO ANY OTHER DMX SENDING DEVICE AS CONTENTION ON THE DMX512 INPUT WILL RESULT.

In Manual Mode, the Braq Cube can be controlled directly from its rear panel without the need of a DMX console or a DMX control device. Standalone control capabilities vary according to the factory setting in use (Four Color and Three Color). Factory settings are password protected but can be adjusted. Contact the manufacturer for more information.

(All stand-alone, DMX address and configuration settings are non-volatile, meaning they will not change if power is lost or switched off and restored. When set to manual mode the Braq Cube operates as a DMX Master and is sending DMX512 data.)



Manual Mode

Braq Cube 4C & 4CA

Manual mode allows you to set the color of your fixture's LEDs adjusting the intensity of the LEDs using the rear panel and the LCD display. The current value of each setting is shown on the main screen.

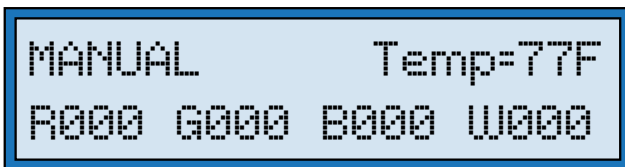

To adjust color values, press the **MENU** key until the desired color is listed on the LCD screen. Press **OK**. Use the ▲ or ▼ keys to select a value between “0” and “255”. Then press OK. Press MENU to select the next color.



Manual Mode

Braq Cube WNC/3W

When set to Manual Mode, the WNC allows you to set the color of your fixture by adjusting the intensity of the LEDs using the rear panel and the LCD display. The current value of each setting is shown on the main screen.

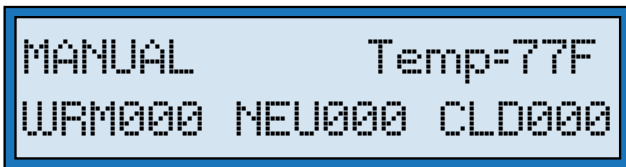

To adjust color values, press the **MENU** key until the desired color is listed on the LCD screen. Press **OK**. Use the ▲ or ▼ keys to select a value between “0” and “255”. Then press **OK**. Press **MENU** to select the next color.

Color Temperature:

WRM = 2700K

NEU = 4000K

CLD = 6500K



Color Wash Mode

Color wash is only available in Braq Cube 4C. In Color Wash mode, the 4C & 4CA automatically cycles through its entire saturated color spectrum by modulating the intensity of the red, green and blue LEDs.



COLOR WASH Temp=77F
Time00:15 Offset=000

There are two user settings that can be adjusted in Color Wash mode. The current value of each setting is shown on the main screen.



Color Wash Mode

Wash Timer

The wash timer determines how long it takes for the Braq Cube to complete an entire color cycle, and, by extension, the rate at which the colors change. Choose a short time for a rapid wash or a longer time for a slower wash. To change the Wash Timer, press **MENU** and select “**CHANGE WASH TIMER?**” by pressing **OK**. Use the ▲ or ▼ keys to select a Wash Time between 15 seconds and 60 minutes (in 15 second intervals).

Wash Offset

When set to Color Wash Mode, the Braq Cube is operating as a DMX master and is sending DMX512 data, allowing it to control unique color washes on up to fourteen additional fixtures in a chain (set to DMX mode).

NOTE: SLAVE FIXTURES SHOULD BE SET TO DMX MODE AND ASSIGNED TO CHANNELS FIVE, NINE, THIRTEEN, ETC (IN FOUR CHANNEL INCREMENTS).

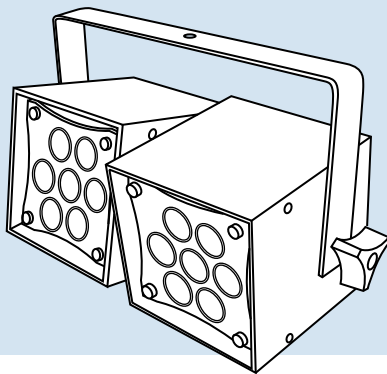

Use the Wash Offset function to control the interaction between multiple Braq Cubes in a Color Wash chain. The Wash Offset determines the length of delay between each light, or how long it takes to “pass” a color from one light to the next. Set the Wash Offset to “0” and the lights will color wash in unison, displaying the same color at the same time. Create a multi-fixture Chasing Rainbow effect, where color passes from light to light, by increasing the Wash Offset. The larger the offset time, the longer it takes for a color to pass to the next light.

To change the Wash Offset, press **MENU** and select **“CHANGE WASH OFFSET?”** by pressing **OK**. Use the **←** and **→** keys to select the time delay (up to 511 seconds) between lights.



Serial Mode

In Serial mode, the unit is controlled by the serial data it receives on the XLR connector located on the rear panel or via CubeConnect®. If your unit does not have Serial Mode you will need to enable it by entering **FACTORY SETUP** using the **MENU** button. For the password enter “**3270**”. Using the **MENU** button to toggle through the options select **SET CONFIG OPTIONS** and click **OK**. Next use the **MENU** button to toggle through the options select **SERIAL MODE ON** and click **OK**. Finally click **OK** to exit.

The serial address required to control the fixture is dependent on the factory setting in use. See p.16 for Braq DMX channels.

Serial Address

To change the Serial address, press **MENU** until “**CHANGE SER ADDRESS?**” appears on the LCD, and press **OK**. Select the desired Serial address using the ▲ or ▼ keys, and press **OK**.



Beam Angles

The beam angle can be easily adjusted using a spread lens. Using a Braq Cube without a spread lens will create a 12° beam angle.

WARNING: DISCONNECT THE POWER CABLE BEFORE REMOVING THUMBSCREWS.

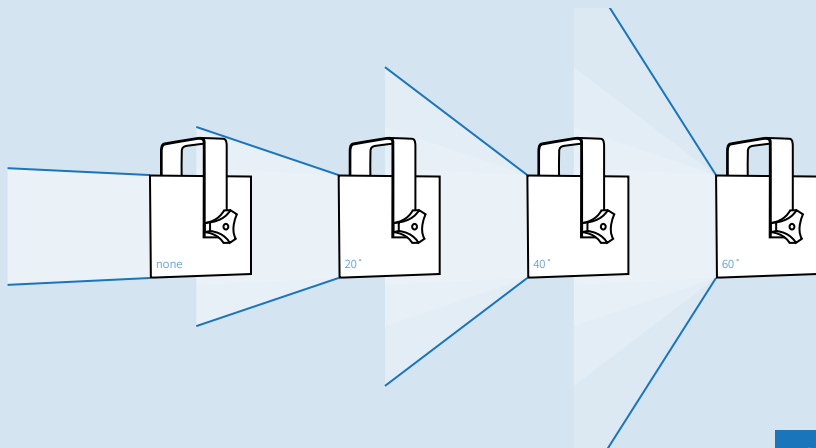



Beam Angles

To change the spread lens, unscrew the thumbscrews from the front panel and remove the acrylic panel. Replace the existing spread lens with the lens of your choice. Place the acrylic panel on top and secure it with four thumbscrews.

NOTE: Custom spread lenses are available upon request.

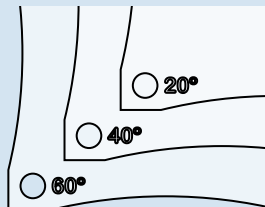
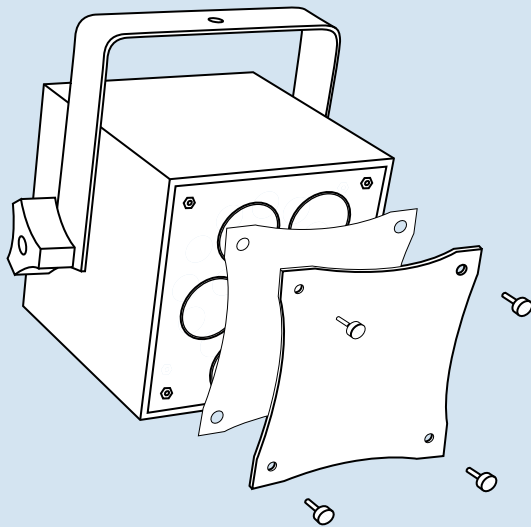



Mounting

WARNING: DISCONNECT THE POWER CABLE BEFORE MAKING ANY CONFIGURATION ADJUSTMENTS.

Linear Arrays:

The Braq Cube can be used as a single fixture or in multi-fixture arrays.

NOTE: ADDITIONAL YOKES AND THREADED ROD ARE REQUIRED.

To connect multiple fixtures, remove the threaded rod by unscrewing one of the side knobs and using the other to pull the rod out. Slide off the yoke and washers and put them to the side.

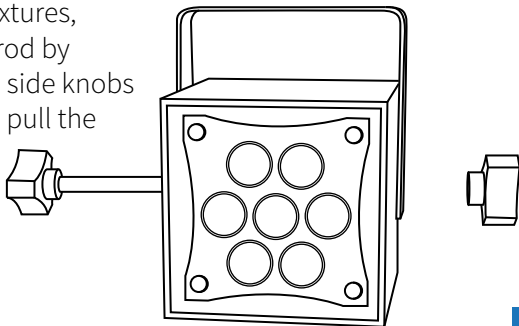

Place the fixtures next to each other. Attach a knob to one side of the double length threaded rod. Slide the double bracket around the fixtures. Align the holes and position spacers on both sides of each fixture (do not use multiple spacers between fixtures).

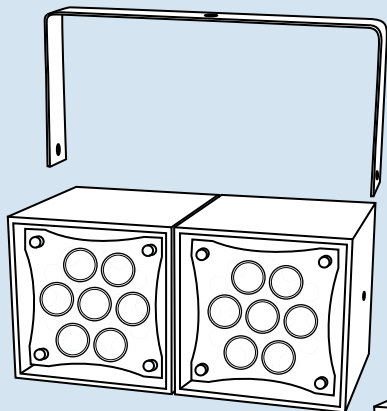

Insert the rod on the left side. Slide the rod through the bracket and both fixtures and secure it with a knob on the right side.

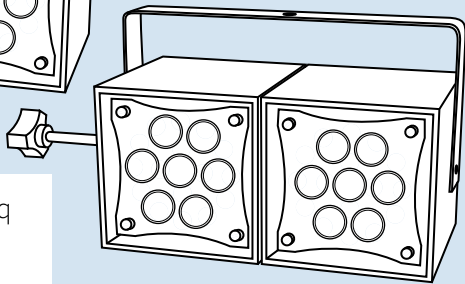

A maximum of three Braq Cubes can be arrayed linearly using provided hanging brackets.





Safety Cables

Single Braq Cubes as well as arrays can be suspended from truss or other major support structures using 3rd party clamping devices. When used in suspended applications, a safety cable (provided by others) is recommended as a positive retaining means between the main support structure and each Braq Cube using the “safety cable hole.”

NOTE: The cable can be threaded through, or clip can be snapped directly onto the safety cable hole.

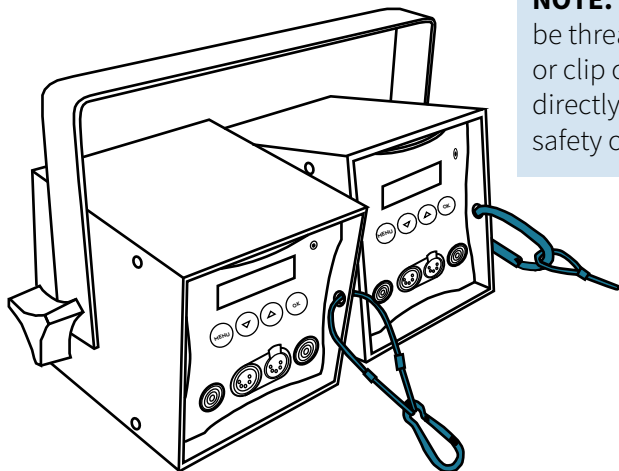



FCC Warning

This equipment has been tested and found to comply with the regulations for a Class A digital device, pursuant to Part 15 of the FCC Rules. These limits are designed to provide reasonable protection against harmful interference when the equipment is operated in a commercial environment. This equipment generates, uses, and can radiate radio frequency energy and, if not installed and used in accordance with this user's guide, may cause harmful interference to radio communications. Operation of this equipment in a residential area is likely to cause harmful interference, in which case the user will be required to correct the interference at his own expense.



General Precautions

1. The use of a safety cable is recommended when rigging the fixture.
2. Before use, make sure all screws and safety points are secured.
3. Make sure the light is unplugged before performing any service to the unit.
4. **ALWAYS** keep this product out of reach of children and untrained persons.
5. **ALWAYS** adhere to safety instructions and warnings, including any and all instructions set forth in the Product Specifications.
6. To allow for proper cooling, airflow must not be restricted through the front and rear of the fixture - do not block off the front or rear panel.
7. For Dry locations/Indoor use only.



Warning Messages

The Braq Cube has warning messages built in that will instruct you when an action needs to be taken.

On startup, if a DMX signal is not present on the DMX connectors, and the fixture is set to DMX mode, all of the LEDs will glow dimly. This feature can be used for troubleshooting your DMX control lines. Once DMX is detected the fixture will instantaneously respond to the command it is given.

The Braq Cube is equipped with an internal temperature sensor. If an overheat condition is experienced all of the red LEDs will glow dimly and a warning message will be displayed on the rear LCD. If this occurs unplug the power connector from the unit and wait three seconds. Plug the fixture in again. If the same condition occurs again contact the manufacturer.



Notes



Notes



Notes

ROSCO

W W W . R O S C O . C O M

BRAQ CUBE®

DESIGNED BY THE BLACK TANK